

NOVOFORMA_AT 



Novo  forma
S I S T E M A S

Tfno. (34) 942 52 01 12 • Fax: (34) 942 52 01 61
www.novoforma.com • e-mail: info@novoforma.com
39710 Solares (Cantabria)
SPAIN





*La atención y el cuidado de los detalles
permite el arte y la calidad en el acabado*

KENNETH S. LEONG

*Nuestro compromiso con la excelencia es el
elemento esencial del trabajo de calidad.*



was sie
was sie
was sie
was sie



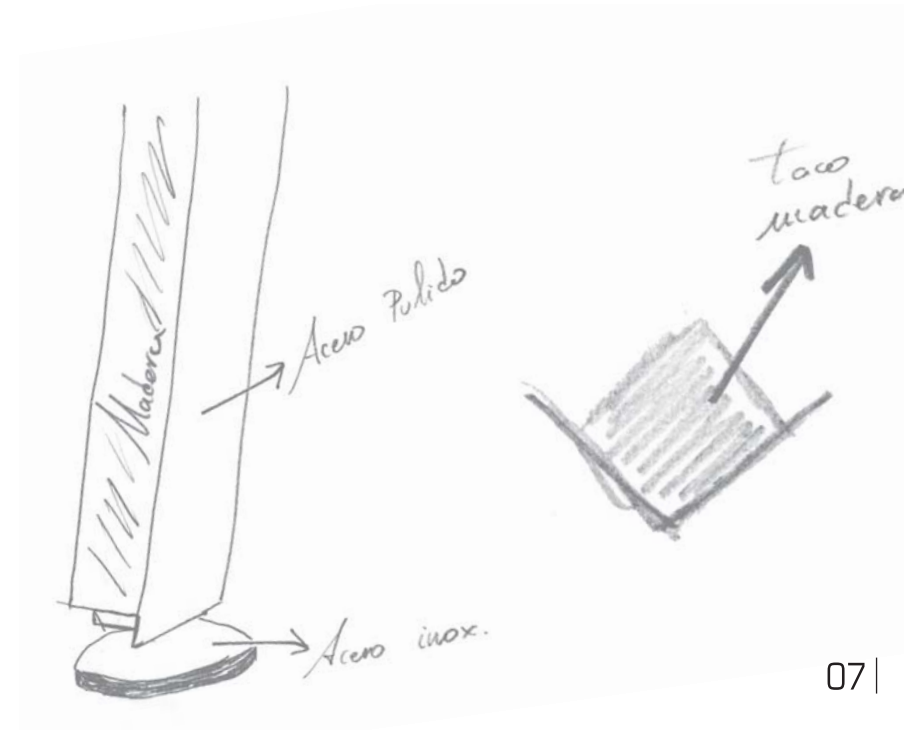

Niveladores inox con 1,5 cm. de regulación

Stainless steel table levellers, adjustable in 1,5 cm.

Niveleurs de bureau en inox avec régulation de 1,5 cm.

niveladores de mesa inoxidável com 1,5 cm de regulação

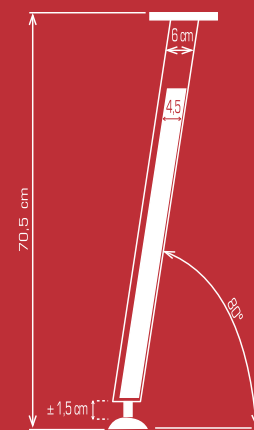



Encimera y embellecedor de pie de mesa de MDF de 2,5 cm de espesor. Cantos biselados y lacados.

Table top and leg trim in 2,5 cm MDF, with lacquered and bevelled edges.

Plateau de table et enjoliveur du pied fabriqué en MDF de 2,5 cm d'épaisseur, chants biseautés et laqués.

Tampo e pés de mesa de MDF com 2,5 cm de espessura, cantos biselados e lacados



mojed
walnut
mayer
moqueira



10 |

11 |



 mesa rectangular
NOVOFORMA_AT
rectangular table | table rectangulaire | mesa rectangular

zebrano
zebrano
zebrano wood
zebrano



was gie
was gie
was gie
was gie

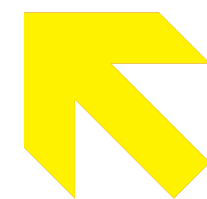

mesa de reuniones

NOVOFORMA_AT

meeting table | table de réunion | mesa de reuniones

Cerero
cherry
censier
cerjeim



roble
oak
chêne
carvalho



18 |

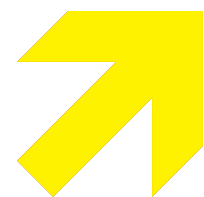

mesa octogonal

NOVOFORMA_AT

octogonal table | table octogonale | mesa octogonal

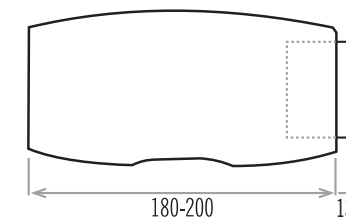

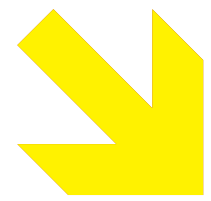

alas de mesa

NOVOFORMA_AT

table wing | retour de table | ala da mesa

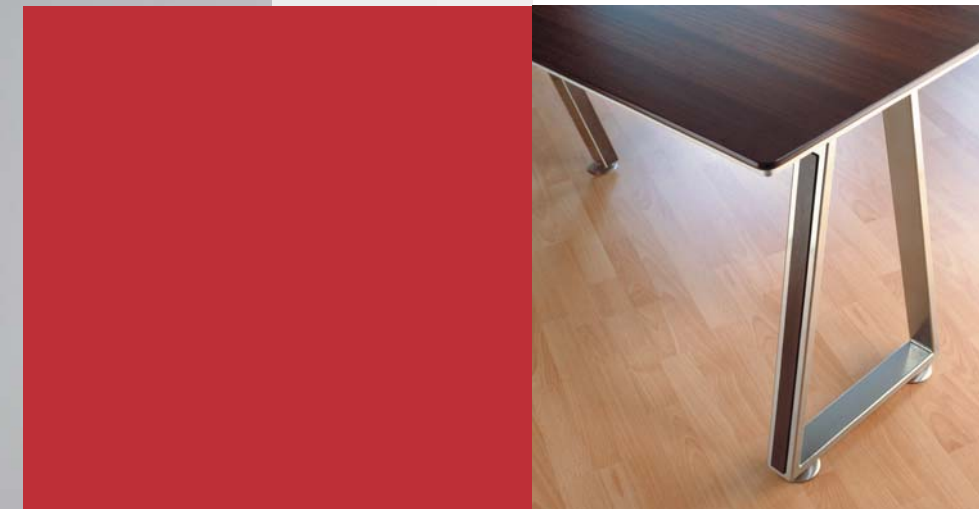
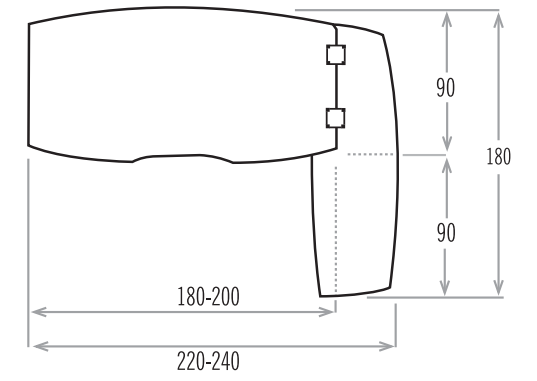

*haya
beech
alètre
faier*



**DESIGNAT
WORK**

ACABADOS
FINISHINGS
FINITIONS
ACABAMENTOS

madera

wood / bois / madeira

cerezo
cherry
cerisier
cerejeira

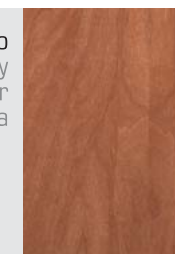

haya
beech
hêtre
faia

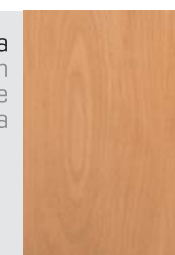

estratificado

estratified / stratifié
/ estratificado

wengué
wengue
wengue
wengue



nogal
walnut
noyer
nogueira

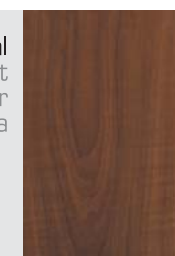

roble
oak
chêne
carvalho

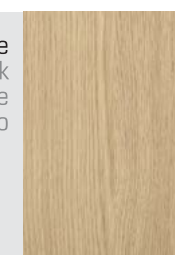

zebrano
zebrano
zebrawood
zebrano

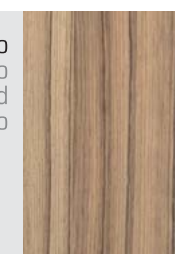

Nous avons une vaste variété d'armoires en 3 hauteurs: 74 cm., 160 cm. et 200 cm., ainsi que 2 largeurs différentes: 90 cm. et 45 cm., avec la possibilité d'incorporer des portes battantes, des portes coulissantes, tiroirs pour dossiers suspendus, des portes vitrées avec le cadre en bois ou avec le cadre en aluminium.

Également nous avons des modules de rayonnage autoportantes de 220 cm. de hauteur et 90 cm. de largeur. Nous avons incorporé aussi une armoire complètement innovatrice de 160 cm. de hauteur avec 2 modules latéraux de 45 cm. de large et un module central de 90 cm., avec 2 portes vitrées coulissantes de 45 cm. de large et cadre d'aluminium.



armarios y complementos
NOVOFORMA_AT

cabinets | armoires | armários

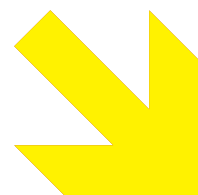

Disponemos de una amplia variedad de armarios de 3 alturas: 74 cm., 160 cm. y 200 cm. y dos anchuras diferentes: 90 cm. y 45 cm., con la posibilidad de incorporar puertas batientes, puertas correderas, archivadores, vitrinas con marco de madera y vitrinas con marco de aluminio.

Ofrecemos además módulos de estanterías autoportantes de 220 cm. de alto y 90 cm. de ancho. Incorporamos a su vez un innovador armario de 160 cm. de altura con dos módulos laterales de 45 cm. de ancho y un módulo central de 90 cm. de ancho, con dos vitrinas correderas con marco de aluminio de 45 cm. de ancho cada una.

We offer a wide range of cabinets, either 74 cm., 160 cm. or 200 cm. height, and either 90 cm. or 45 cm. width. They can also have either hinged doors, sliding doors, or filing drawers, with the possibility of adding glass doors with wooden frame or aluminium frame.

220 cm. height self-standing shelf modules are also available in this line. We introduce as well an innovative cabinet 160 cm. height, with two lateral modules of 45 cm. width, plus a central module 90 cm. width, with two sliding aluminium framed glass doors 45 cm. width each.

